

Ultra-Fast Recovery Diodes 60A FRED

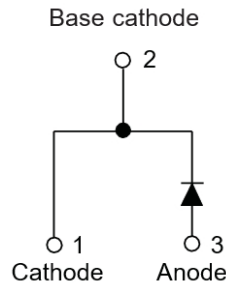

Features

- High frequency operation
- High surge forward current capability
- High purity, high temperature epoxy encapsulation for enhanced mechanical strength and moisture resistance
- Guard ring for enhanced ruggedness and long term reliability
- Solder dip 275 °C max. 7 s, per JESD 22-B106

Typical Applications

Typical applications are in switching power supplies, converters, freewheeling diodes, and reverse battery protection.

Mechanical Data

- **Package:** TO-247AC
Molding compound meets UL 94 V-0 flammability rating, RoHS-compliant
- **Terminals:** Tin plated leads, solderable per J-STD-002 and JESD22-B102
- **Polarity:** As marked

■ Maximum Ratings (T_j=25°C Unless otherwise specified)

PARAMETER	SYMBOL	UNIT	MUR6060P
Device marking code			MUR6060P
Repetitive Peak Reverse Voltage	VRRM	V	600
Average Rectified Output Current @60Hz half sine-wave, R-load, T _c (FIG.1)	I _o	A	60
Surge(Non-repetitive)Forward Current @60Hz half sine-wave, 1 cycle, T _j =25°C	I _{FSM}	A	500
Current Squared Time @1ms≤t≤8.3ms T _j =25°C	I ² t	A ² s.	1037
Single Pulse Avalanche Energy @ T _p =40uS, T _j =25°C, L=15mH	EAS	mJ	900
Storage Temperature	T _{stg}	°C	-55 ~ +175
Junction Temperature	T _j	°C	-55 ~ +175
Typical Junction capacitance @4V, 1MHz	C _j	pF	392



MUR6060P

■Electrical Characteristics (T_j=25°C Unless otherwise specified)

PARAMETER	SYMBOL	UNIT	TEST CONDITIONS	Min	Typ	Max	
instantaneous forward voltage drop per diode	V _{FM}	V	I _{FM} =60.0A T _j =25°C	-	1.8	2.4	
DC reverse current at rated DC blocking voltage per diode	I _{RRM1}	μA	V _{RM} =V _{RRM} T _j =25°C	-	-	5.0	
	I _{RRM2}		V _{RM} =V _{RRM} T _j =125°C	-	-	200	
Reverse Recovery Time	T _{rr}	ns	I _F =0.5A I _{RM} =1A I _{RR} =0.25A T _j =25°C	-	50	75	
			T _j =25°C	-	69.78	-	
			T _j =125°C	-	101.20	-	
Peak recovery current	I _{RRM}	A	T _j =25°C	I _F =30A di/dt=-200A/μs V _{RM} =200V	-	4.540	-
			T _j =125°C		-	10.98	-
Reverse recovery charge	Q _{rr}	nC	T _j =25°C	-	158.44	-	
			T _j =125°C	-	555.70	-	

■Thermal Characteristics (T_j=25°C Unless otherwise specified)

PARAMETER		SYMBOL	UNIT	MUR6060P
Thermal Resistance	Between junction and case	R _{θJ-C}	°CW	1.0

■Ordering Information (Example)

PREFERRED P/N	UNIT WEIGHT(g)	MINIIMUM PACKAGE(pcs)	INNER BOX QUANTITY(pcs)	OUTER CARTON QUANTITY(pcs)	DELIVERY MODE
MUR6060P	Approximate 6.0	30	360	1800	Tube

■Characteristics (Typical)

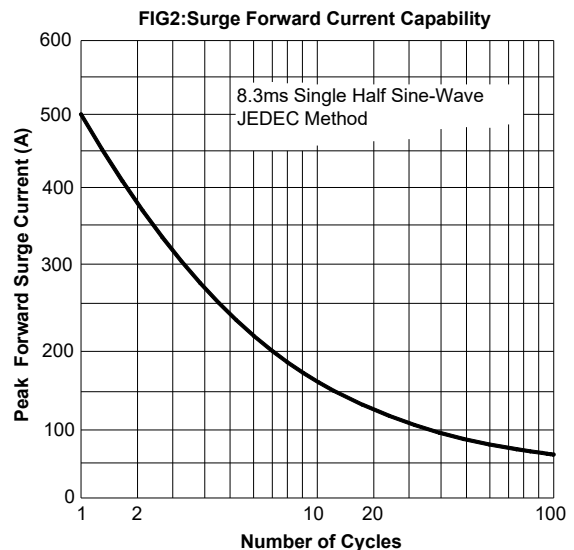
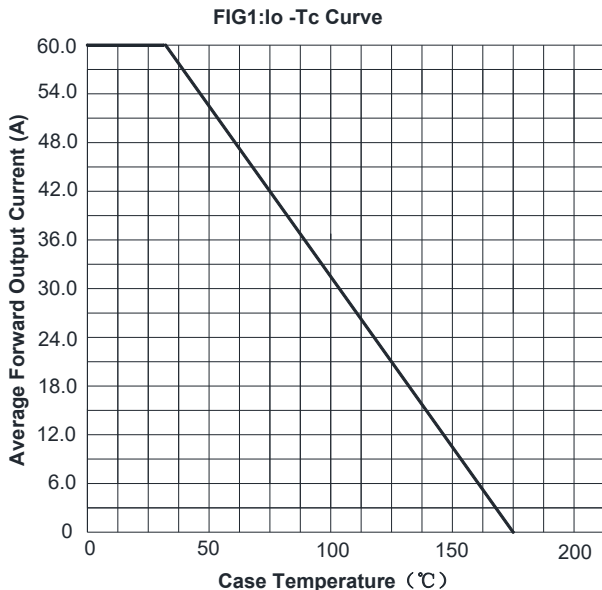

FIG3: Forward Voltage

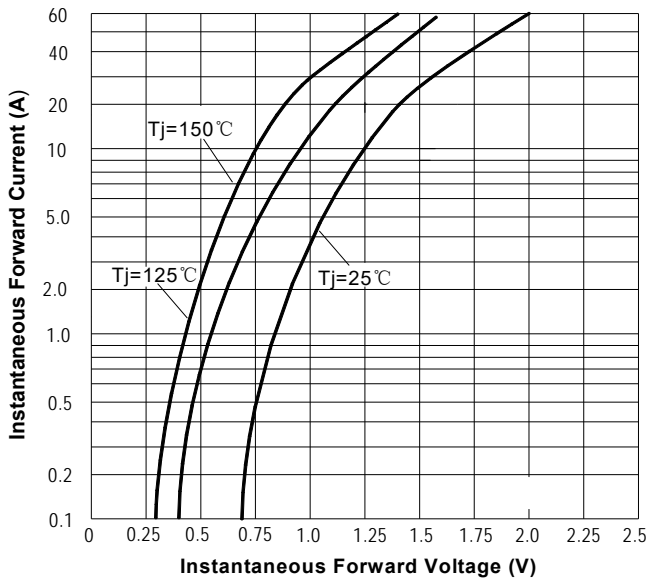

FIG4: Typical Reverse Characteristics

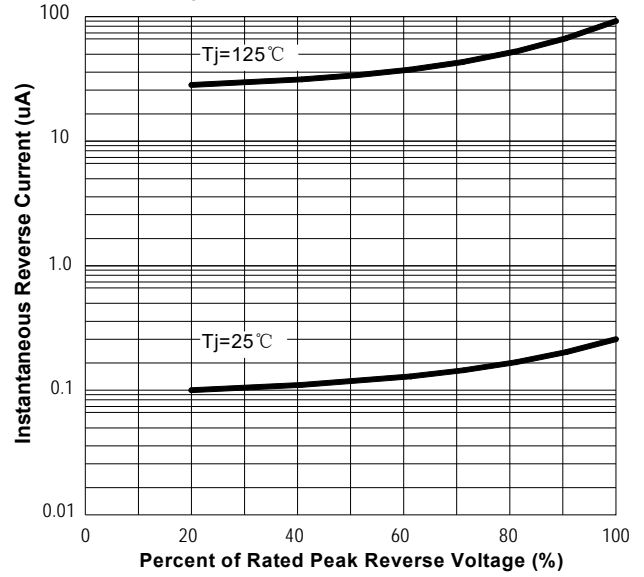
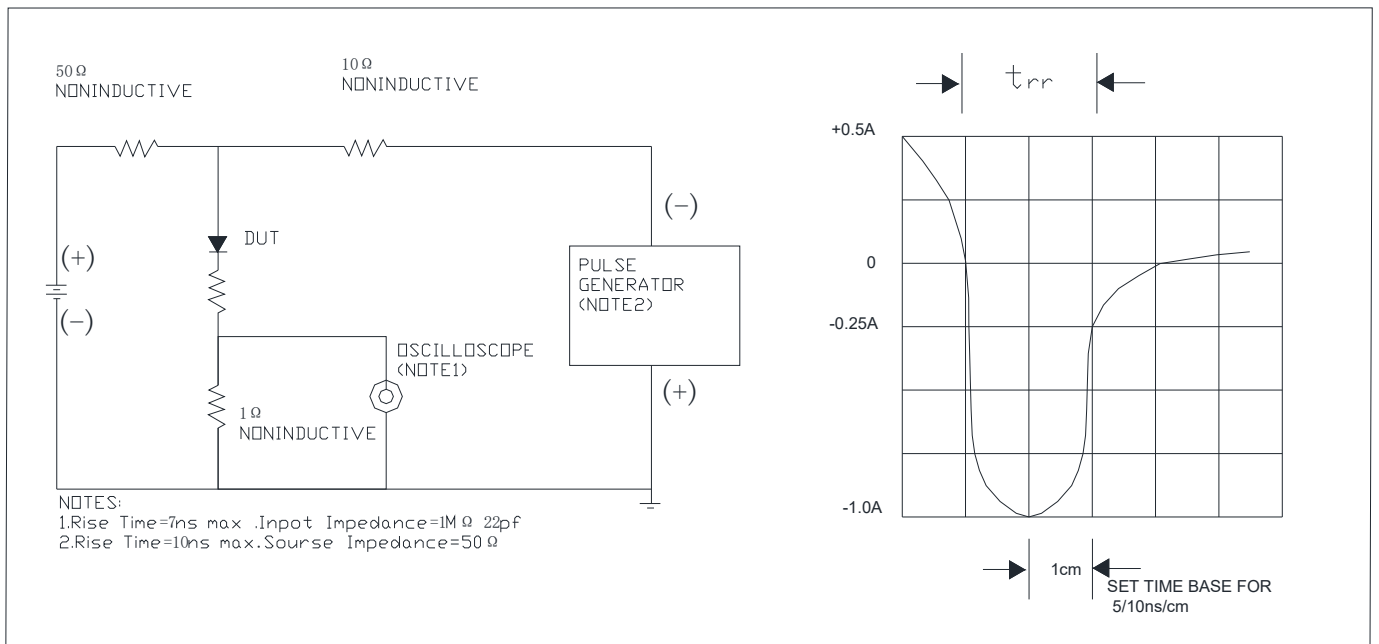

FIG.5 Diagram of circuit and Testing wave form of reverse recovery time





MUR6060P

■Outline Dimensions

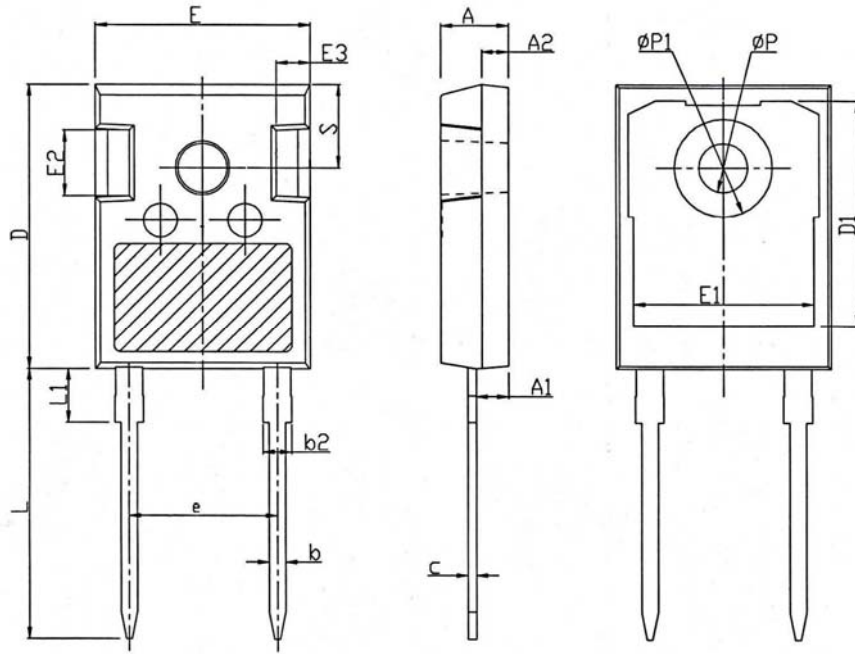

TO-247AC		
Dim	Min	Max
A	4.80	5.20
A1	2.21	2.61
A2	1.85	2.15
b	1.11	1.36
b2	1.91	2.21
c	0.51	0.75
D	20.70	21.30
D1	16.25	16.85
E	15.50	16.10
E1	13.00	13.60
E2	4.80	5.20
E3	2.30	2.70
e	10.88BSC	
L	19.62	20.22
L1	-	4.30
φ P	3.40	3.80
φ P1	-	7.30
S	6.15BSC	



MUR6060P

Disclaimer

The information presented in this document is for reference only. Yangzhou Yangjie Electronic Technology Co., Ltd. reserves the right to make changes without notice for the specification of the products displayed herein to improve reliability, function or design or otherwise.

The product listed herein is designed to be used with ordinary electronic equipment or devices, and not designed to be used with equipment or devices which require high level of reliability and the malfunction of which would directly endanger human life (such as medical instruments, transportation equipment, aerospace machinery, nuclear-reactor controllers, fuel controllers and other safety devices), Yangjie or anyone on its behalf, assumes no responsibility or liability for any damages resulting from such improper use of sale.

This publication supersedes & replaces all information previously supplied. For additional information, please visit our website [http:// www.21yangjie.com](http://www.21yangjie.com) , or consult your nearest Yangjie's sales office for further assistance.