

High Speed Switching Diode

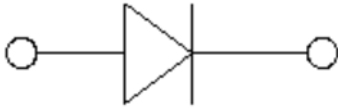

Features

- Moisture sensitivity level 1
- Reverse voltage: 75V
- Average forward current : 150mA

Application

- High frequency rectifier
- Signal switching

Mechanical data

- **Package:** SOD-323
- **Terminals:** Tin plated leads, solderable per J-STD-002 and JESD22-B102

■ Maximum Ratings (T_a=25°C Unless otherwise specified)

Parameter	Symbol	Unit	Value
Device marking code			T4
Repetitive peak reverse voltage	V _{RRM}	V	100
Forward current	I _F	mA	150
Non-repetitive surge peak forward current @ t=8.3ms half-sine wave	I _{FSM}	A	1
Non-repetitive surge peak forward current @ t=1ms square wave			1.5
Non-repetitive surge peak forward current @ t=1μs square wave			2
Power dissipation	P _D	mW	200
Junction temperature	T _J	°C	-55 to +150
Storage temperature	T _{STG}	°C	-55 to +150



1N4148WS

■ Electrical Characteristics (T_a=25°C Unless otherwise specified)

Parameter	Symbol	Unit	Conditions	Min	Typ	Max
Breakdown voltage	V _R	V	I _R =1uA	75		
Forward voltage	V _F	V	I _F =10mA			1
Reverse leakage current	I _{R1}	nA	V _R =20V			25
	I _{R2}	uA	V _R =75V			1
Junction capacitance	C _j	pF	V _R = 0V, f =1MHZ			4
Reverse recovery time	T _{rr}	ns	I _F =10mA, V _R =6V, I _{rr} =1mA, R _L =100Ω			4

■ Thermal Characteristics

Parameter	Symbol	Unit	Value
Thermal resistance, junction-to-ambient	R _{θJ-A} ⁽¹⁾	°C/W	625
Thermal resistance, junction-to-case	R _{θJ-C} ⁽¹⁾	°C/W	500

Note:

(1) Thermal resistance from junction to ambient and from junction to case mounted on P.C.B. with 8mm*9mm copper pad areas



1N4148WS

■ Characteristics

Fig 1: P_D - T_a Curve

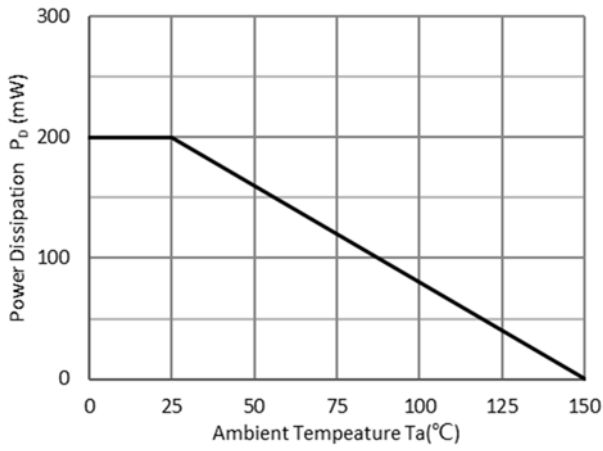

Fig 2: Capacitance Capability

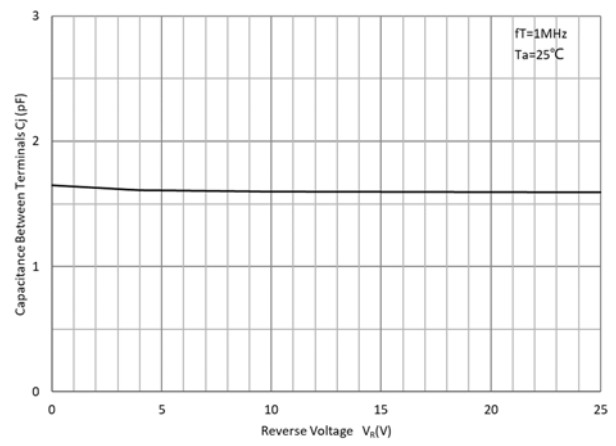

Fig 3: Typical Forward Characteristics

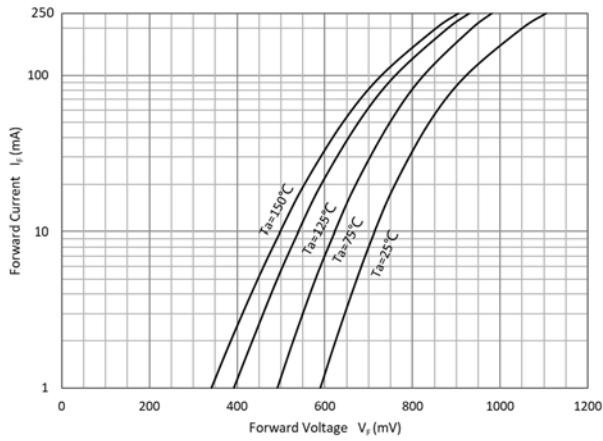
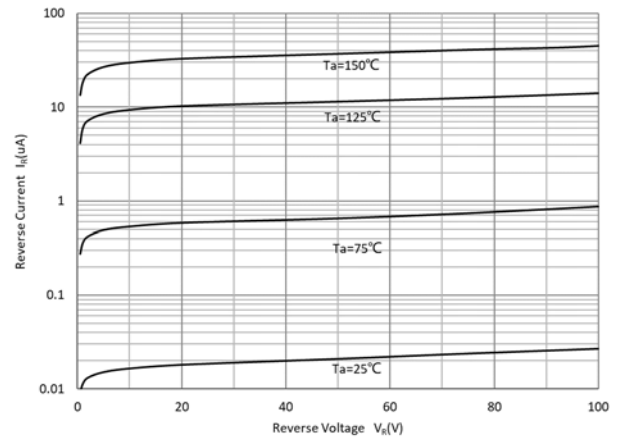

Fig 4: Typical Reverse Characteristics





1N4148WS

■ Ordering Information

Preferred P/N	Packing code	Unit weight(g)	Minimum package(pcs)	Inner box quantity(pcs)	Outer carton quantity(pcs)	Delivery mode
1N4148WS	F2	Approximate 0.0048	3000	30000	120000	7" reel
1N4148WS	F3	Approximate 0.0048	10000	/	210000	13" reel

■ Outline Dimensions

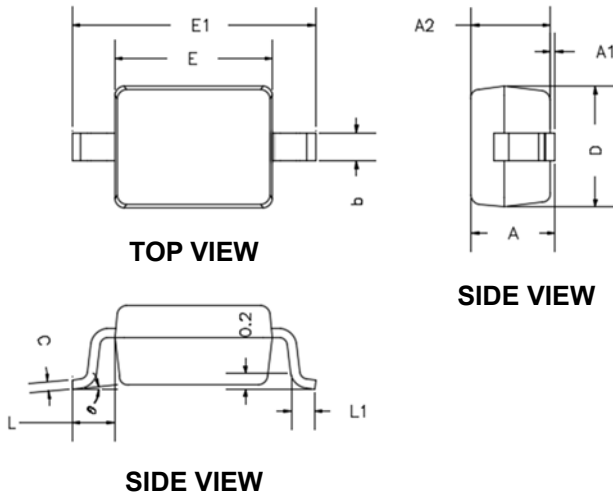

DIMENSIONS				
DIM	INCHES		MM	
	MIN	MAX	MIN	MAX
A	---	0.0393	---	1.0000
A1	0.0000	0.0039	0.0000	0.1000
A2	0.0314	0.0354	0.8000	0.9000
b	0.0098	0.0157	0.2500	0.4000
c	0.0031	0.0059	0.0800	0.1500
D	0.0472	0.0551	1.2000	1.4000
E	0.0629	0.0709	1.6000	1.8000
E1	0.0984	0.1063	2.5000	2.7000
L	0.0187TYP		0.475TYP	
L1	0.0098	0.0157	0.250	0.400
θ	0°	8°	0°	8°

■ Suggested Pad Layout

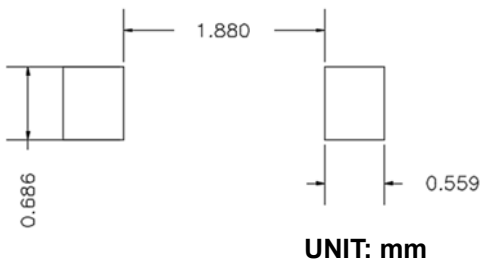



1N4148WS

Disclaimer

The information presented in this document is for reference only. Yangzhou Yangjie Electronic Technology Co., Ltd. reserves the right to make changes without notice for the specification of the products displayed herein to improve reliability, function, or design or otherwise.

The product listed herein is designed to be used with ordinary electronic equipment or devices, and not designed to be used with equipment or devices which require high level of reliability and the malfunction of which would directly endanger human life (such as medical instruments, transportation equipment, aerospace machinery, nuclear-reactor controllers, fuel controllers and other safety devices), Yangjie or anyone on its behalf, assumes no responsibility or liability for any damages resulting from such improper use of sale.

This publication supersedes & replaces all information previously supplied. For additional information, please visit our website [http:// www.21yangjie.com](http://www.21yangjie.com) , or consult your nearest Yangjie's sales office for further assistance.