

## N-Channel Enhancement Mode Field Effect Transistor

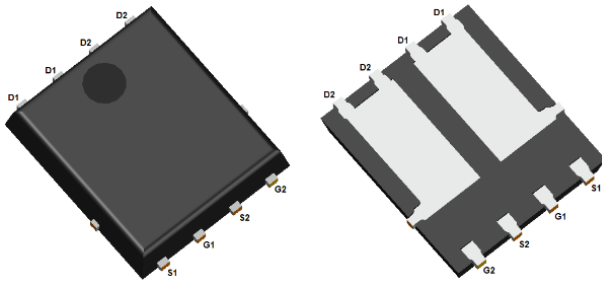

Top View

Bottom View

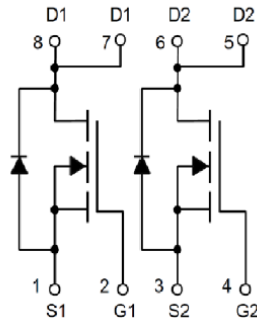

PDFN5060-8L

### Product Summary

NMOS(Die1/Die2)

- $V_{DS}$  100V
- $I_D$  20A
- $R_{DS(ON)}$ ( at  $V_{GS}=10V$ ) <22 mohm
- $R_{DS(ON)}$ ( at  $V_{GS}=4.5V$ ) <27 mohm

### General Description

- Split gate trench MOSFET technology
- High density cell design for low  $R_{DS(ON)}$
- High Speed switching
- Moisture Sensitivity Level 1
- Epoxy Meets UL 94 V-0 Flammability Rating
- Halogen Free
- Part no. with suffix "Q" means AEC-Q101 qualified

### Applications

- DC-DC Converters
- Power management functions
- Industrial and Motor Drive application
- 12V, 24V and 48V Automotive systems

### ■ Absolute Maximum Ratings ( $T_A=25^\circ\text{C}$ unless otherwise noted)

Parameter		Symbol	N-Die1/Die2	Unit
Drain-source Voltage		$V_{DS}$	100	V
Gate-source Voltage		$V_{GS}$	$\pm 20$	V
Drain Current	$T_C=25^\circ\text{C}$	$I_D$	20	A
	$T_C=100^\circ\text{C}$		13	
	$T_A=25^\circ\text{C}$		7	
	$T_A=100^\circ\text{C}$		4.5	
Pulsed Drain Current <sup>A</sup>		$I_{DM}$	80	A
Avalanche energy <sup>B</sup>		$E_{AS}$	81	mJ
Total Power Dissipation <sup>C</sup>	$T_C=25^\circ\text{C}$	$P_D$	50	W
	$T_C=100^\circ\text{C}$		20	
	$T_A=25^\circ\text{C}$		2.5	
	$T_A=100^\circ\text{C}$		1	
Junction and Storage Temperature Range		$T_J, T_{STG}$	-55~+150	$^\circ\text{C}$

### ■ Thermal resistance

Parameter		Symbol	Typ	Max	Units
Thermal Resistance Junction-to-Ambient <sup>D</sup>	Steady-State	$R_{\theta JA}$	40	50	$^\circ\text{C/W}$
Thermal Resistance Junction-to-Case	Steady-State	$R_{\theta JC}$	2	2.5	



# YJGD20G10BQ

## ■ Ordering Information (Example)

PREFERRED P/N	PACKING CODE	Marking	MINIMUM PACKAGE(pcs)	INNER BOX QUANTITY(pcs)	OUTER CARTON QUANTITY(pcs)	DELIVERY MODE
YJGD20G10BQ	F1	YJGD20G10B	5000	10000	100000	13" reel

## ■ NMOS(Die1/Die2) Electrical Characteristics (T<sub>J</sub>=25°C unless otherwise noted)

Parameter	Symbol	Conditions	Min	Typ	Max	Units
<b>Static Parameter</b>						
Drain-Source Breakdown Voltage	BV <sub>DSS</sub>	V <sub>GS</sub> = 0V, I <sub>D</sub> =250μA	100			V
Zero Gate Voltage Drain Current	I <sub>DSS</sub>	V <sub>DS</sub> =100V, V <sub>GS</sub> =0V			1	μA
Gate-Body Leakage Current	I <sub>GSS</sub>	V <sub>GS</sub> = ±20V, V <sub>DS</sub> =0V			±100	nA
Gate Threshold Voltage	V <sub>GS(th)</sub>	V <sub>DS</sub> = V <sub>GS</sub> , I <sub>D</sub> =250μA	1.0	1.8	2.5	V
Static Drain-Source On-Resistance	R <sub>DS(ON)</sub>	V <sub>GS</sub> = 10V, I <sub>D</sub> =20A		16	22	mΩ
		V <sub>GS</sub> = 4.5V, I <sub>D</sub> =10A		18	27	
Diode Forward Voltage	V <sub>SD</sub>	I <sub>S</sub> =20A, V <sub>GS</sub> =0V		0.9	1.3	V
Gate Resistance	R <sub>g</sub>	f=1MHz		1.5		Ω
<b>Dynamic Parameters</b>						
Input Capacitance	C <sub>iss</sub>	V <sub>DS</sub> =25V, V <sub>GS</sub> =0V, f=1MHZ		1240		pF
Output Capacitance	C <sub>oss</sub>			740		
Reverse Transfer Capacitance	C <sub>rss</sub>			25		
<b>Switching Parameters</b>						
Total Gate Charge	Q <sub>g</sub>	V <sub>GS</sub> =10V, V <sub>DS</sub> =50V, I <sub>D</sub> =20A		17		nC
Gate-Source Charge	Q <sub>gs</sub>			6		
Gate-Drain Charge	Q <sub>gd</sub>			3		
Reverse Recovery Charge	Q <sub>rr</sub>	I <sub>F</sub> =20A, di/dt=100A/us		42		ns
Reverse Recovery Time	t <sub>rr</sub>			40		
Turn-on Delay Time	t <sub>D(on)</sub>	V <sub>GS</sub> =10V, V <sub>DD</sub> =50V, I <sub>D</sub> =20A R <sub>GEN</sub> =3.0Ω		40		ns
Turn-on Rise Time	t <sub>r</sub>			12		
Turn-off Delay Time	t <sub>D(off)</sub>			55		
Turn-off fall Time	t <sub>f</sub>			16		

A. Repetitive rating; pulse width limited by max. junction temperature.

B. V<sub>DD</sub>=50V, R<sub>G</sub>=25Ω, L=2mH, I<sub>AS</sub>=9A.

C. Pd is based on max. junction temperature, using junction-case thermal resistance.

D. The value of RθJA is measured with the device mounted on 1in2 FR-4 board with 2oz. Copper, in a still air environment with TA =25° C. The Power dissipation PDSM is based on RθJA ≤ 10s and the maximum allowed junction temperature of 150° C. The value in any given application depends on the user's specific board design.



# YJGD20G10BQ

## ■ NMOS(Die1/Die2) Typical Performance Characteristics

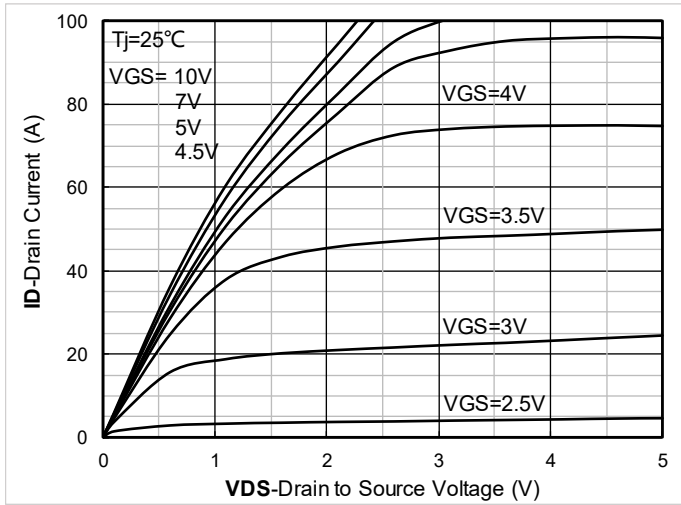

Figure1. Output Characteristics

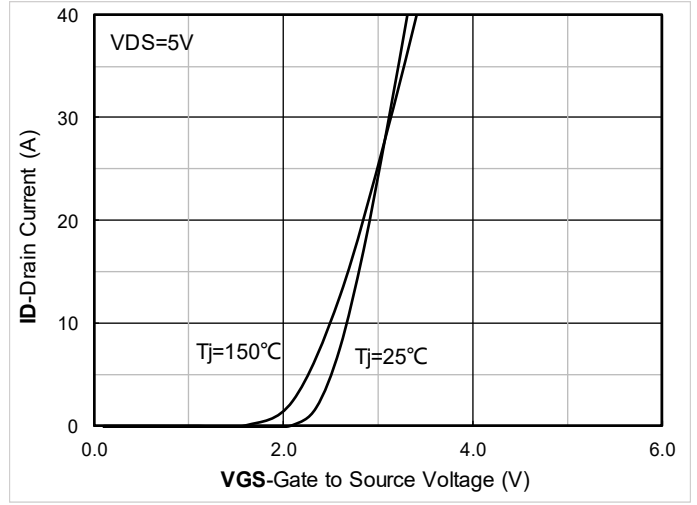

Figure2. Transfer Characteristics

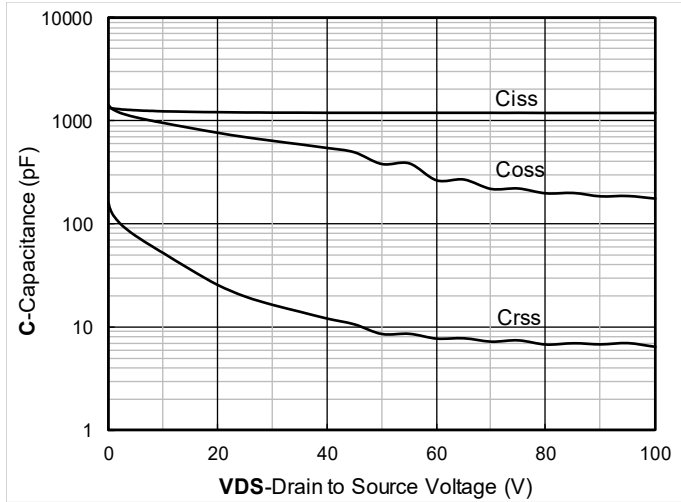

Figure3. Capacitance Characteristics

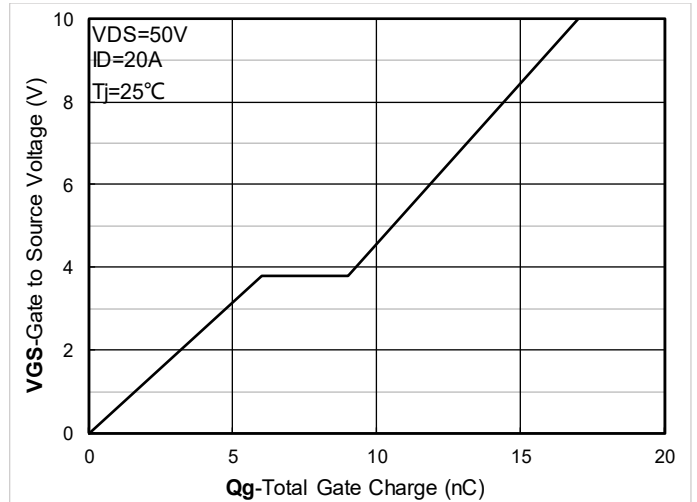

Figure4. Gate Charge

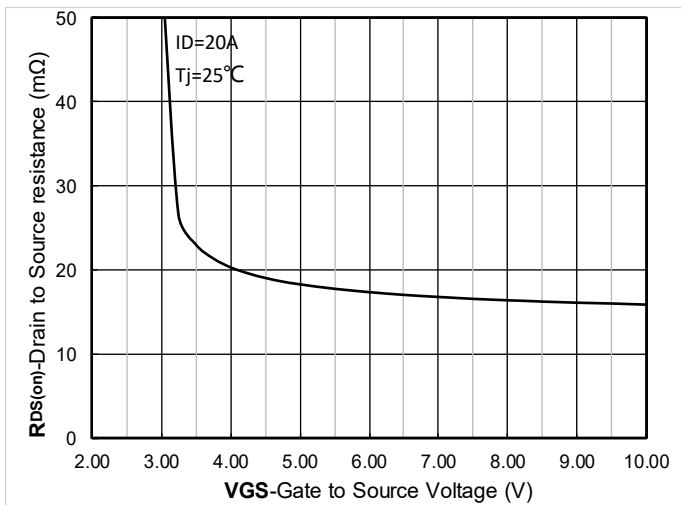

Figure5. On-Resistance vs. Gate to Source Voltage

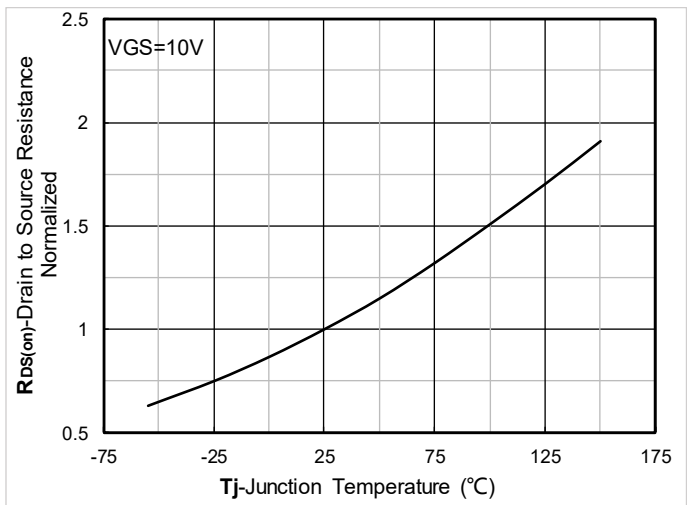

Figure6. Normalized On-Resistance



# YJGD20G10BQ

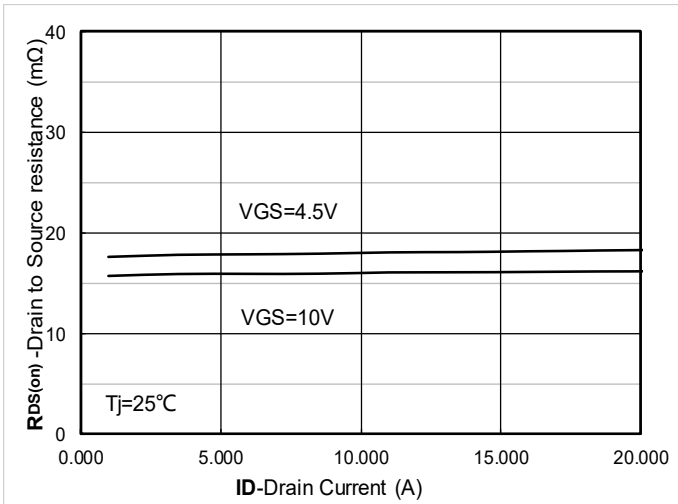

Figure 7. RDS(on) VS Drain Current

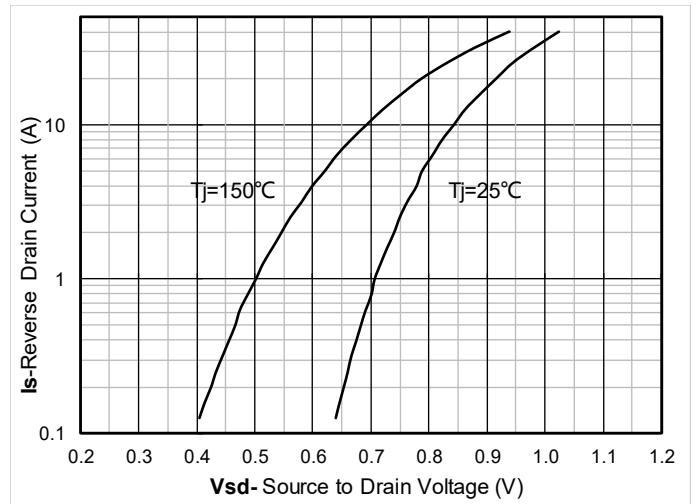

Figure 8. Forward characteristics of reverse diode

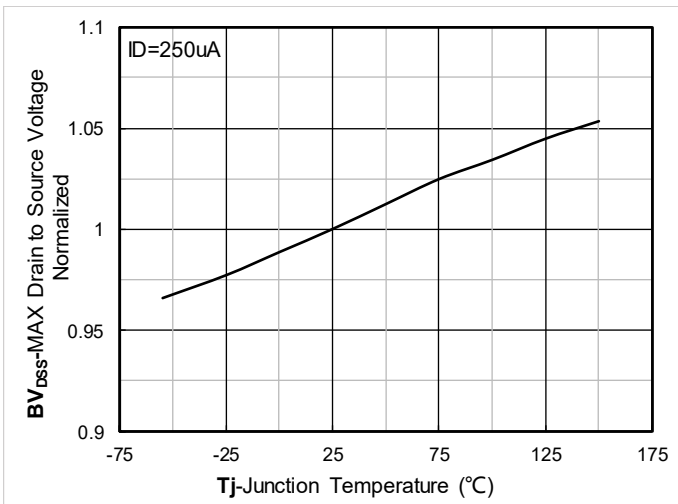

Figure 9. Normalized breakdown voltage

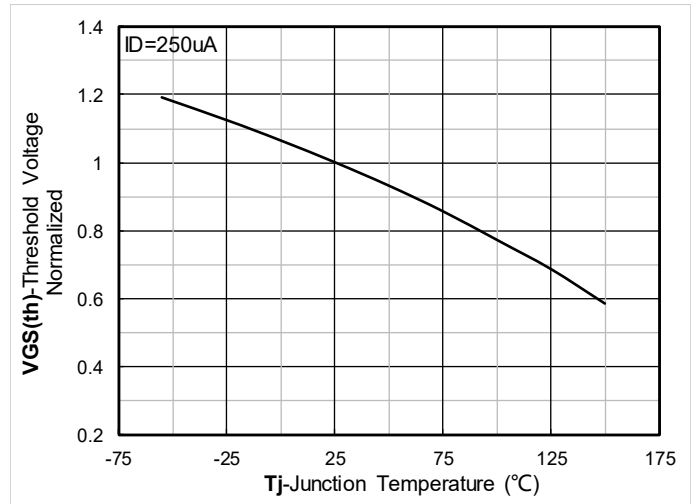

Figure 10. Normalized Threshold voltage

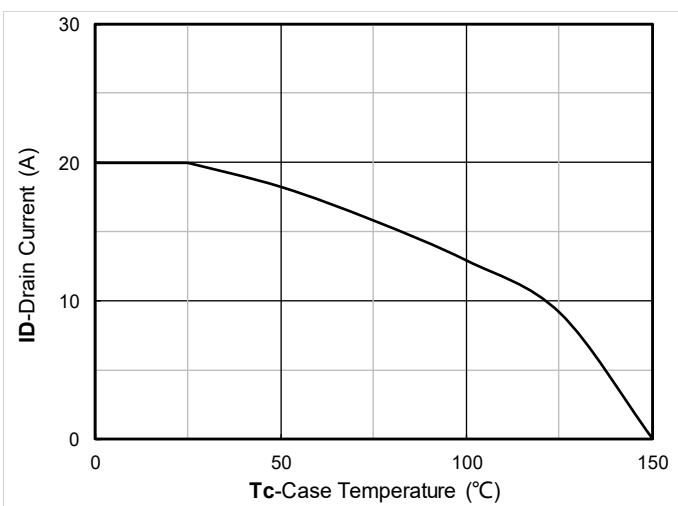

Figure 11. Current dissipation

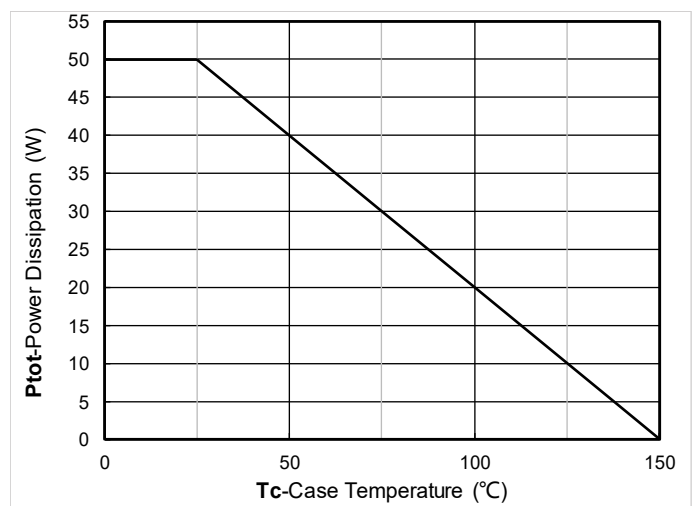

Figure 12. Power dissipation



# YJGD20G10BQ

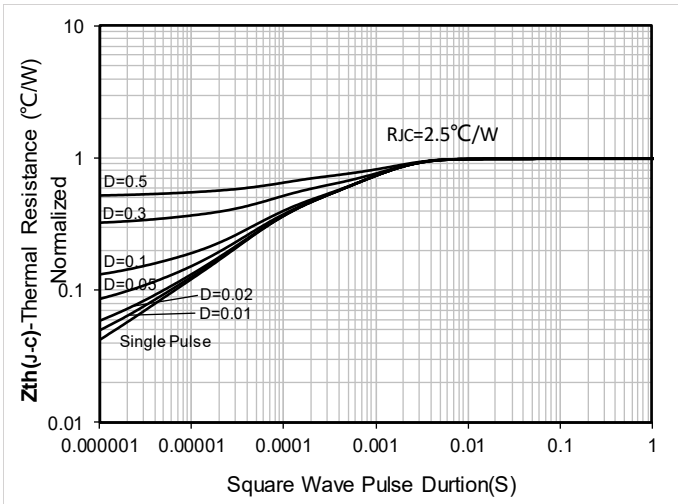

Figure 13. Maximum Transient Thermal Impedance

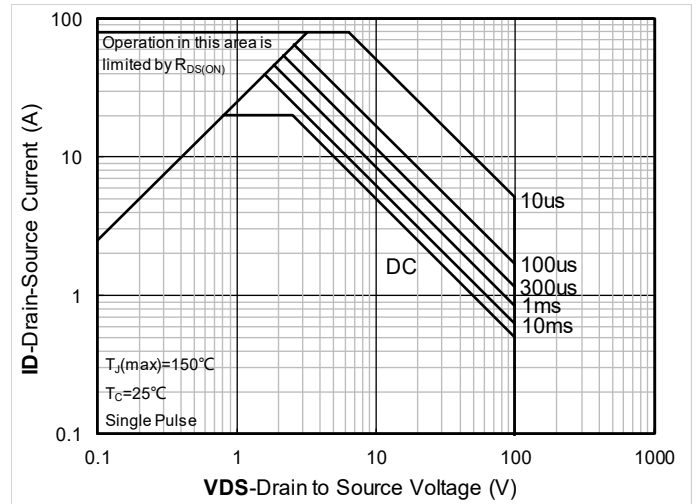
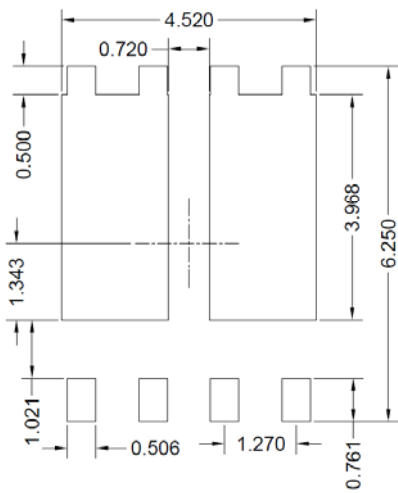
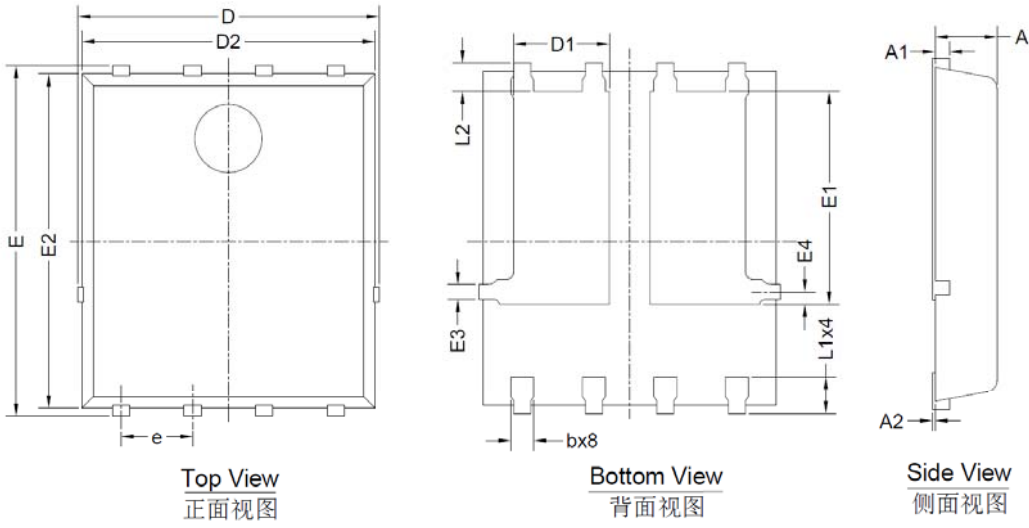

Figure 14. Safe Operation Area



# YJGD20G10BQ

## ■ PDFN5060-8L Package information



Suggested Solder Pad Layout  
Top View

SYMBOL	MILLIMETER		
	MIN	NOM	MAX
D	5.15	5.35	5.55
E	5.95	6.15	6.35
A	1.00	1.10	1.20
A1	0.254 BSC		
A2			0.10
D1	1.50	1.70	1.90
E1	3.52	3.72	3.92
D2	5.00	5.20	5.40
E2	5.66	5.86	6.06
E3	0.254 REF		
E4	0.21 REF		
L1	0.56	0.66	0.76
L2	0.50 BSC		
b	0.31	0.41	0.51
e	1.27 BSC		

Note:

1. Controlling dimension: in millimeters.
2. General tolerance:  $\pm 0.10$  mm.
3. The pad layout is for reference purposes only.



## YJGD20G10BQ

---

### Disclaimer

The information presented in this document is for reference only. Yangzhou Yangjie Electronic Technology Co., Ltd. reserves the right to make changes without notice for the specification of the products displayed herein to improve reliability, function or design or otherwise.

The product listed herein is designed to be used with automotive electronics, are not designed for use in medical, life-saving, lifesustaining, or military, Yangjie or anyone on its behalf, assumes no responsibility or liability for any damages resulting from such improper use of sale.

This publication supersedes & replaces all information previously supplied. For additional information, please visit our website [http:// www.21yangjie.com](http://www.21yangjie.com) , or consult your nearest Yangjie's sales office for further assistance