



Thyristor/Diode Modules

VRRM / VDRM 800 to 1800V
IFAV / ITAV 40A

Applications

- Power Converters
- Lighting Control
- DC Motor Control and Drives
- Heat and temperature control

Features

- International standard package
- High Surge Capability
- Glass passivated chip
- Simple Mounting
- Heat transfer through aluminum oxide DBC ceramic isolated metal baseplate
- UL recognized applied for file no. E360040

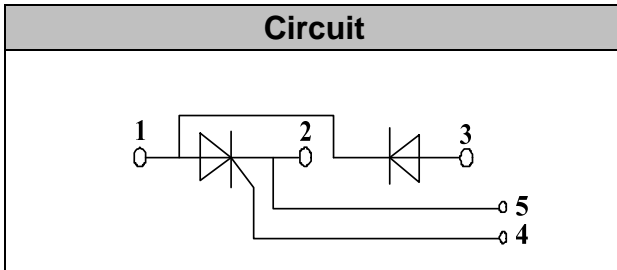

Module Type

| TYPE | VRRM/VDRM | VRSM |
|------------|-----------|-------|
| MT40CB08T1 | 800V | 900V |
| MT40CB12T1 | 1200V | 1300V |
| MT40CB16T1 | 1600V | 1700V |
| MT40CB18T1 | 1800V | 1900V |

◆Diode

Maximum Ratings

| Symbol | Item | Conditions | Values | Units |
|------------------|------------------------------------|----------------------|-------------|------------------|
| ID | Output Current(D.C.) | Tc=85°C | 40 | A |
| IFSM | Surge forward current | t=10mS Tvj =45°C | 1000 | A |
| i ² t | Circuit Fusing Consideration | | 5000 | A ² s |
| Visol | Isolation Breakdown Voltage(R.M.S) | a.c.50HZ;r.m.s.;1min | 3000 | V |
| Tvj | Operating Junction Temperature | | -40 to +125 | °C |
| Tstg | Storage Temperature | | -40 to +125 | °C |
| Mt | Mounting Torque | To terminals(M5) | 3±15% | Nm |
| Ms | | To heatsink(M6) | 5±15% | Nm |
| Weight | Module (Approximately) | | 100 | g |

Thermal Characteristics

| Symbol | Item | Conditions | Values | Units |
|----------|-------------------------|------------------|--------|-------|
| Rth(j-c) | Thermal Impedance, max. | Junction to Case | 0.33 | °C/W |
| Rth(c-s) | Thermal Impedance, max. | Case to Heatsink | 0.10 | °C/W |

Electrical Characteristics

| Symbol | Item | Conditions | Values | | | Units |
|--------|---------------------------------------|---------------------|--------|------|------|-------|
| | | | Min. | Typ. | Max. | |
| VFM | Forward Voltage Drop, max. | T=25°C IF =200A | | | 1.95 | V |
| IRRM | Repetitive Peak Reverse Current, max. | Tvj =25°C VRD=VRRM | ≤0.5 | | | mA |
| | | Tvj =125°C VRD=VRRM | ≤6 | | | mA |



◆Thyristor Maximum Ratings

| Symbol | Item | Conditions | Values | Units |
|-----------|--|---|--------------|----------------------|
| I_{TAV} | Average On-State Current | Sine 180°; $T_c=85^\circ\text{C}$ | 40 | A |
| I_{TSM} | Surge On-State Current | $T_{VJ}=45^\circ\text{C}$ $t=10\text{ms}$, sine $T_{VJ}=125^\circ\text{C}$ $t=10\text{ms}$, sine | 1000 850 | A |
| i^2t | Circuit Fusing Consideration | $T_{VJ}=45^\circ\text{C}$ $t=10\text{ms}$, sine $T_{VJ}=125^\circ\text{C}$ $t=10\text{ms}$, sine | 5000 3600 | A^2s |
| Visol | Isolation Breakdown Voltage(R.M.S) | a.c.50HZ;r.m.s.;1min | 3000 | V |
| T_{vj} | Operating Junction Temperature | | -40 to +125 | $^\circ\text{C}$ |
| T_{stg} | Storage Temperature | | -40 to +125 | $^\circ\text{C}$ |
| M_t | Mounting Torque | To terminals(M5) | $3 \pm 15\%$ | Nm |
| M_s | | To heatsink(M6) | $5 \pm 15\%$ | Nm |
| di/dt | Critical Rate of Rise of On-State Current | $T_{VJ}=T_{VJM}$, $2/3V_{DRM}$, $I_G=500\text{mA}$ $T_r < 0.5\mu\text{s}$, $t_p > 6\mu\text{s}$ | 150 | A/ μs |
| dv/dt | Critical Rate of Rise of Off-State Voltage, min. | $T_J=T_{VJM}$, $2/3V_{DRM}$ linear voltage rise | 1000 | V/ μs |
| a | Maximum allowable acceleration | | 50 | m/s^2 |

Thermal Characteristics

| Symbol | Item | Conditions | Values | Units |
|---------------|-------------------------|------------------|--------|--------------------|
| $R_{th(j-c)}$ | Thermal Impedance, max. | Junction to Case | 0.65 | $^\circ\text{C/W}$ |
| $R_{th(c-s)}$ | Thermal Impedance, max. | Case to Heatsink | 0.20 | $^\circ\text{C/W}$ |

Electrical Characteristics

| Symbol | Item | Conditions | Values | | | Units |
|-------------------|---|---|--------|------|------|------------------|
| | | | Min. | Typ. | Max. | |
| V_{TM} | Peak On-State Voltage, max. | $T=25^\circ\text{C}$ $I_T=200\text{A}$ | | | 1.95 | V |
| I_{RRM}/I_{DRM} | Repetitive Peak Reverse Current, max. / Repetitive Peak Off-State Current, max. | $T_{VJ}=T_{VJM}$, $V_R=V_{RRM}$, $V_D=V_{DRM}$ | | | 15 | mA |
| V_{TO} | On state threshold voltage | For power-loss calculations only ($T_{VJ}=125^\circ\text{C}$) | | | 1.0 | V |
| r_T | Value of on-state slope resistance. max | $T_{VJ}=T_{VJM}$ | | | 4.5 | $\text{m}\Omega$ |
| V_{GT} | Gate Trigger Voltage, max. | $T_{VJ}=25^\circ\text{C}$, $V_D=6\text{V}$ | | | 2.5 | V |
| I_{GT} | Gate Trigger Current, max. | $T_{VJ}=25^\circ\text{C}$, $V_D=6\text{V}$ | | | 150 | mA |
| V_{GD} | Non-triggering gate voltage, max. | $T_{VJ}=125^\circ\text{C}$, $V_D=2/3V_{DRM}$ | | | 0.25 | V |
| I_{GD} | Non-triggering gate current, max. | $T_{VJ}=125^\circ\text{C}$, $V_D=2/3V_{DRM}$ | | | 6 | mA |
| I_L | Latching current, max. | $T_{VJ}=25^\circ\text{C}$, $R_G=33\Omega$ | | 300 | 600 | mA |
| I_H | Holding current, max. | $T_{VJ}=25^\circ\text{C}$, $V_D=6\text{V}$ | | 150 | 250 | mA |
| tgd | Gate controlled delay time | $T_{VJ}=25^\circ\text{C}$, $I_G=1\text{A}$, $diG/dt=1\text{A}/\mu\text{s}$ | 1 | | | μs |
| tq | Circuit commutated turn-off time | $T_{VJ}=T_{VJM}$ | 80 | | | μs |



Performance Curves

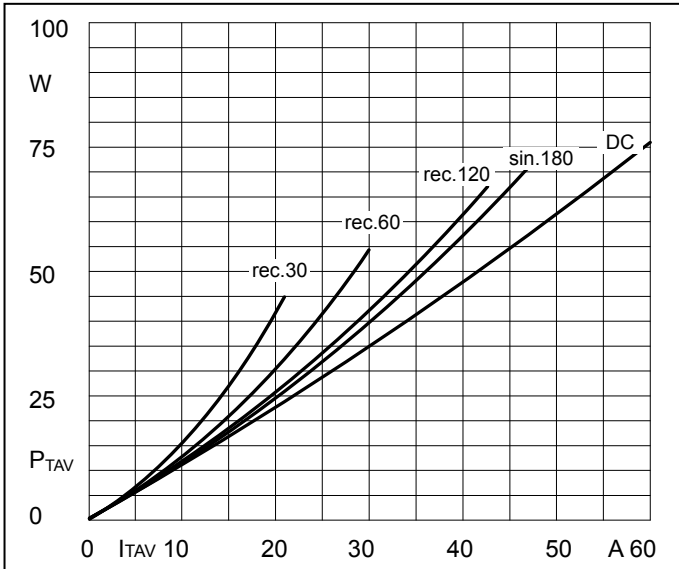

Fig1. Power dissipation

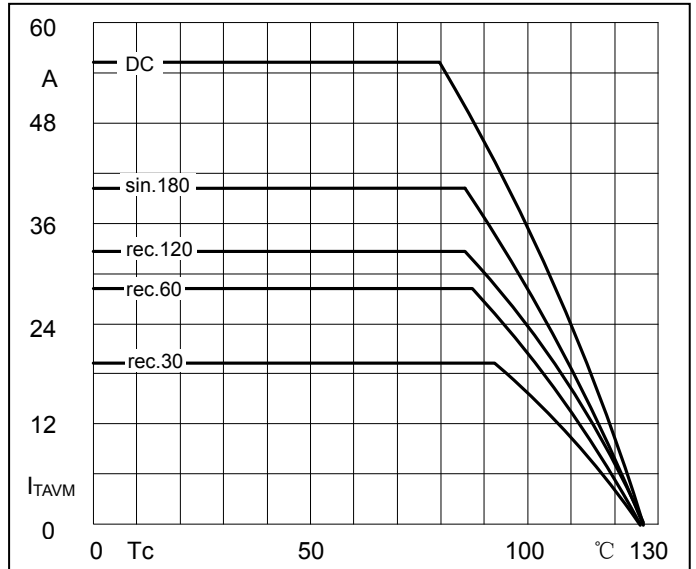

Fig2. Forward Current Derating Curve

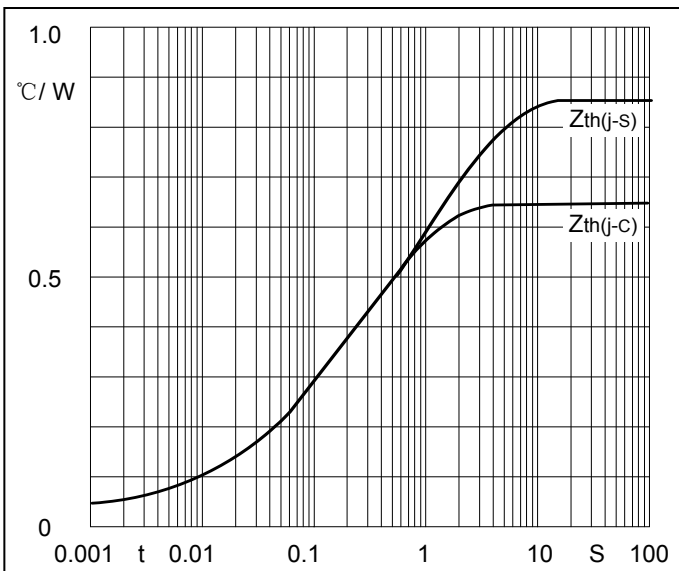

Fig3. Transient thermal impedance

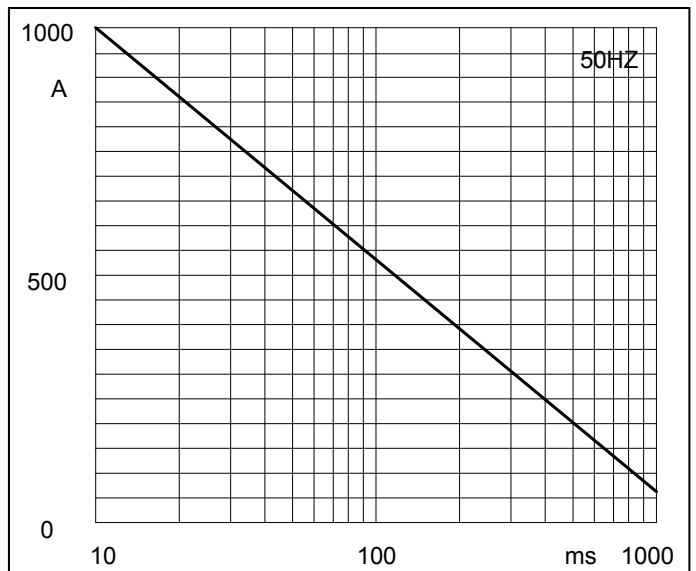

Fig4. Max Non-Repetitive Forward Surge Current

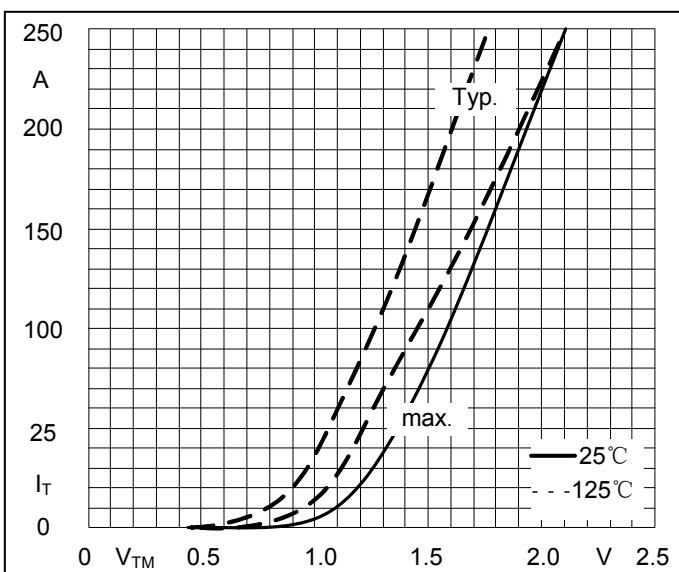

Fig5. Forward Characteristics

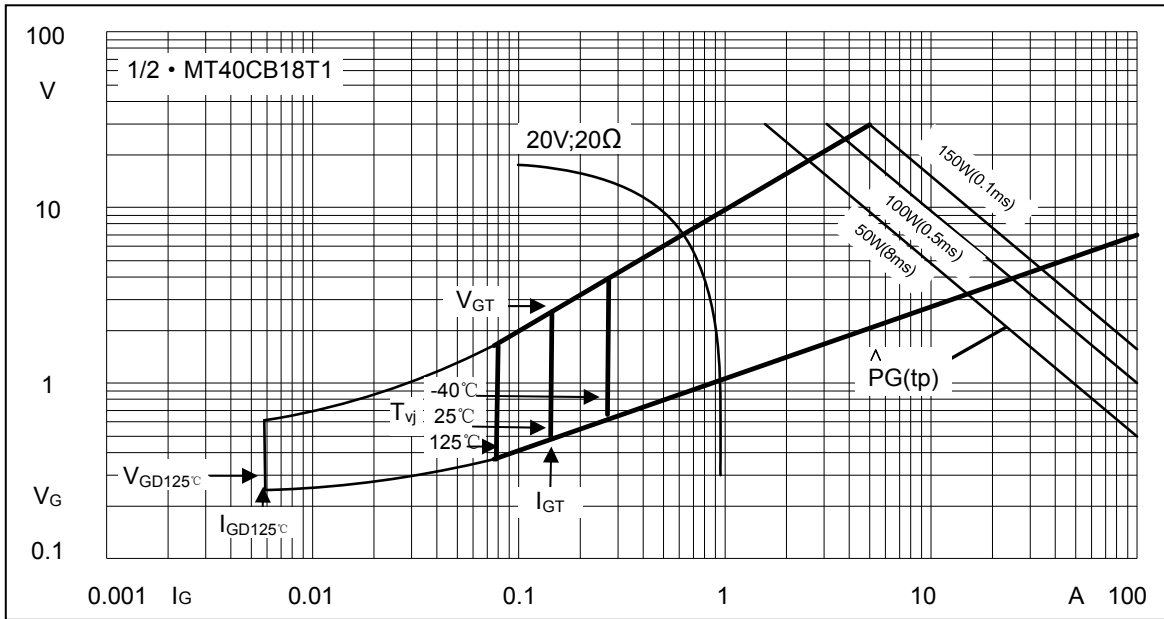
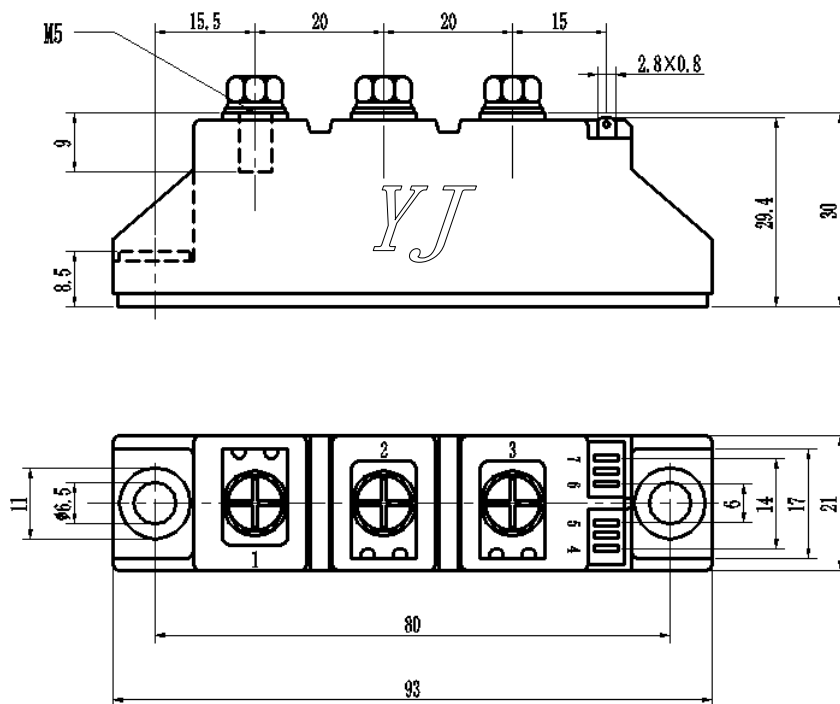

Fig6. Gate trigger Characteristics

Package Outline Information

CASE: T1



Dimensions in mm