

FRED Modules



V_{RRM} 400V

I_{FAV} 200 A

Applications

- Inversion Welder
- Uninterruptible Power Supply (UPS)
- Plating Power Supply
- Ultrasonic Cleaner and Welder
- Power Factor Correction (PFC) Circuit
- Converter & Chopper

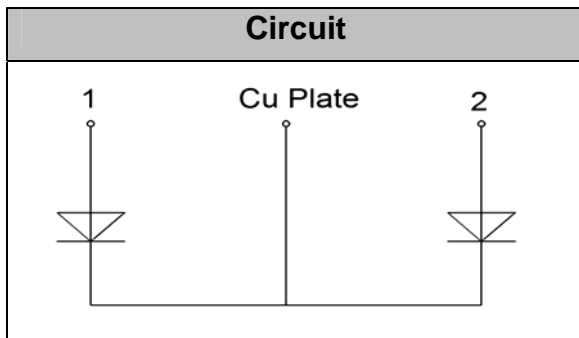

Features

- Soft Reverse Recovery Characteristics
- Ultrafast Reverse Recovery Time
- Low Reverse Recovery Loss
- Low Forward Voltage
- High Surge Current Capability
- Low Inductance Package

Maximum Ratings

Symbol	Conditions	Values	Units
V_R		400	V
V_{RRM}		400	V
$I_{F(AV)}$	$T_C=125^\circ\text{C}$, Per Diode	100	A
	$T_C=125^\circ\text{C}$, Per Module	200	A
	$T_C=125^\circ\text{C}$, 20KHz, Per Module	150	A
$I_{F(RMS)}$	$T_C=125^\circ\text{C}$, Per Diode	150	A
I_{FSM}	1/2 Cycle , 50Hz, Sine	1500	A
	1/2 Cycle , 60Hz, Sine	1800	A
I^2t	$T_J=45^\circ\text{C}$, $t=10\text{ms}$, 50Hz, Sine	11250	A^2s
	$T_J=45^\circ\text{C}$, $t=8.3\text{ms}$, 60Hz, Sine	16200	A^2s
P_D		833	W
T_J		-40 to +150	$^\circ\text{C}$
T_{STG}		-40 to +125	$^\circ\text{C}$
Torque	Recommended (M6)	3~4.7	N·m
Torque	Recommended (M6)	3~4.7	N·m
Weight		92	g

Thermal Characteristics

Symbol	Conditions	Values	Units
$R_{th(j-c)}$	Per diode	0.3	$^\circ\text{C/W}$
$R_{th(j-c)}$	Per Module	0.15	$^\circ\text{C/W}$



Electrical Characteristics

Symbol	Conditions	Values			Units
		Min.	Typ.	Max.	
I_{RM}	$V_R=400V$	--	--	0.5	mA
	$V_R=400V, T_J=125^\circ C$	--	--	1	mA
V_F	$I_F=100A$	--	1.1	1.35	V
	$I_F=100A, T_J=125^\circ C$	--	1.0	1.25	V
t_{rr}	$I_F=1A, V_R=30V, di_F/dt=-200A/\mu s$	--	38	--	ns
t_{rr}	$V_R=200V, I_F=100A, di_F/dt=-200A/\mu s, T_J=25^\circ C$	--	95	--	ns
I_{RRM}		--	8.5	--	A
t_{rr}	$V_R=200V, I_F=100A, di_F/dt=-200A/\mu s, T_J=125^\circ C$	--	150	--	ns
I_{RRM}		--	14	--	A

Performance Curves

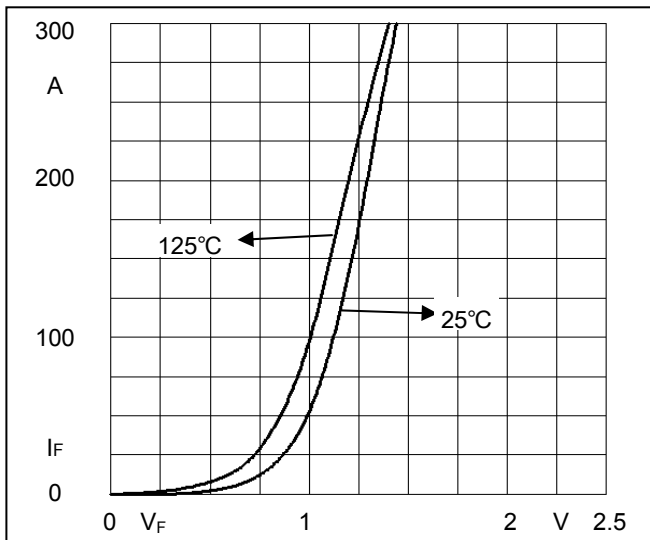

Fig1. Forward Voltage Drop vs Forward Current

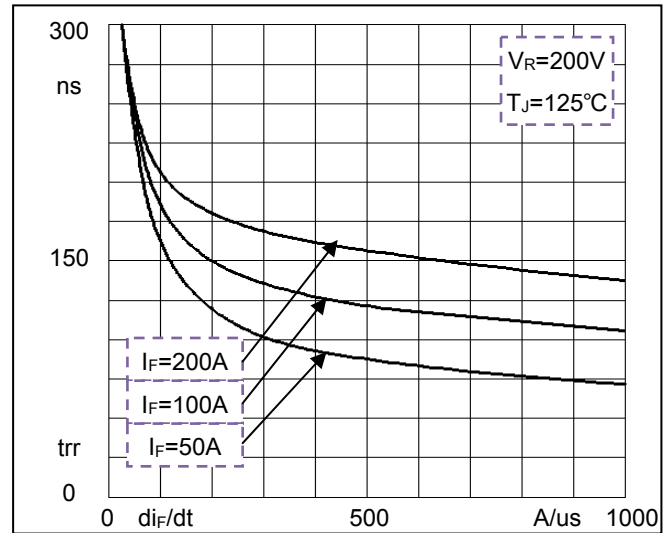

Fig2. Reverse Recovery Time vs di_F/dt

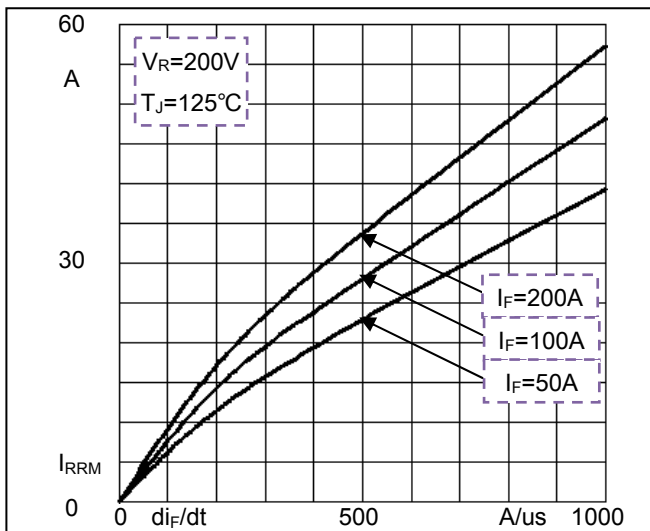

Fig3. Reverse Recovery Current vs di_F/dt

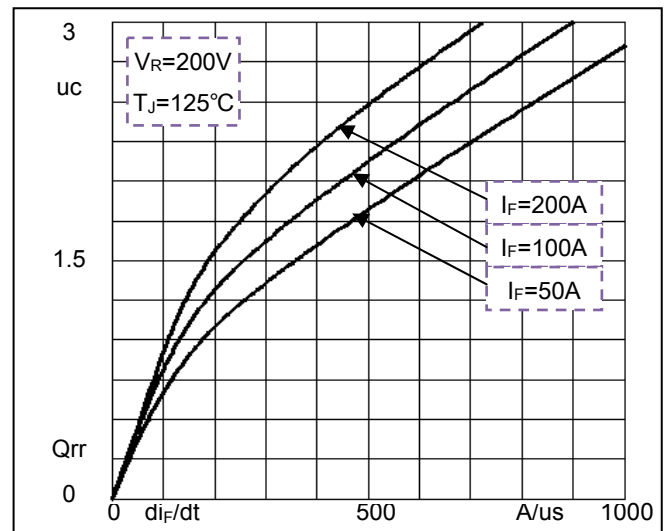
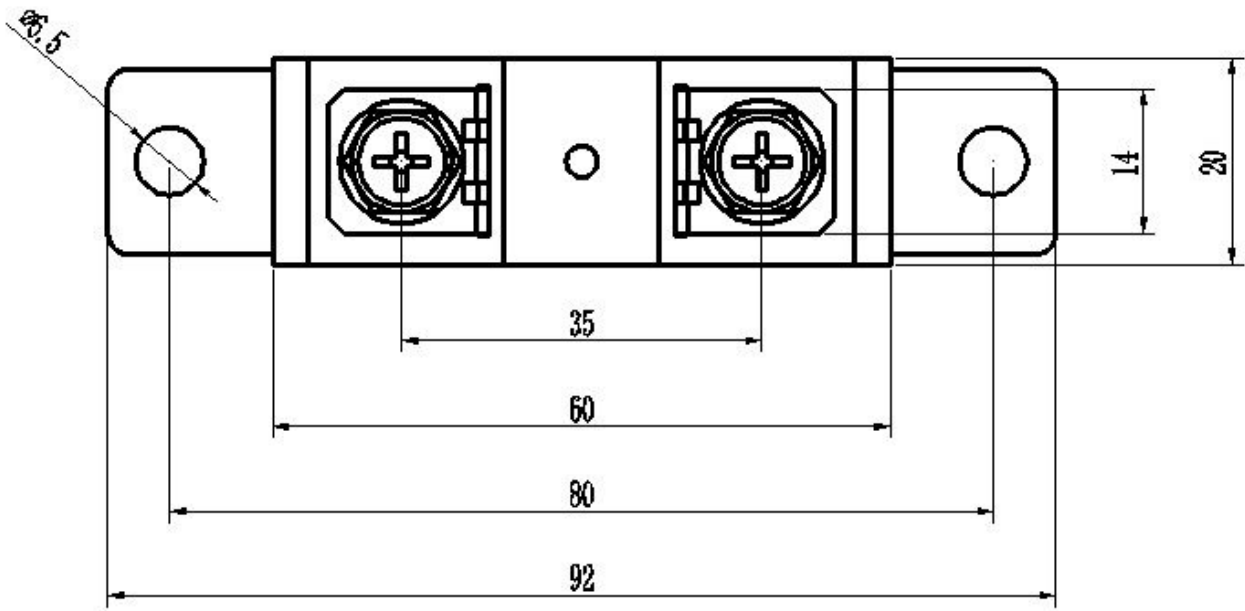
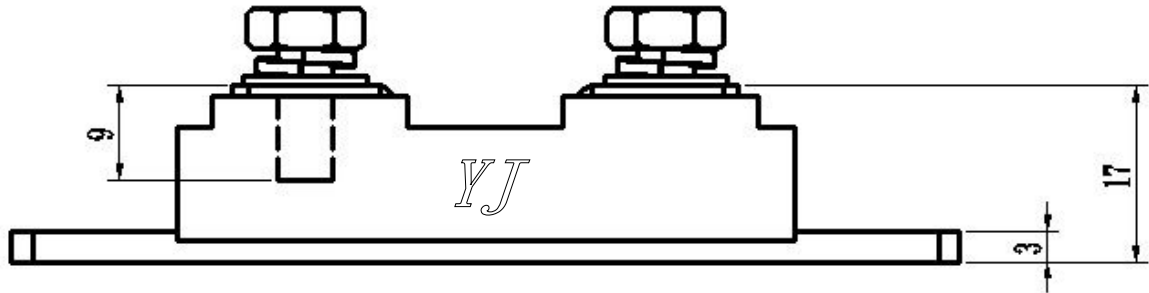

Fig4. Reverse Recovery Charge vs di_F/dt

Package Outline Information

CASE: F4



Dimensions in mm